

PROJECT	_____
TYPE	_____
SPECIFIER	_____
QUANTITY	_____
DATE	_____

## CALIBER 120 D RECESSED

### E12I0036-

base number	Color	Finish	Lens
	Temperature	Options	Options

- To build a product code in our configurator select the specify button on the base model # product page
- To build a manual product code on this datasheet choose from the options listed below in blue font and add the suffix to the base model #

#### GENERAL

Series: Caliber
Subseries: Caliber 120 D
Brand: Unonovesette
Division: Exterior
Mounting Type: Recessed
Mounting Location: In-Ground
Subcategory: Drive Over

#### PHYSICAL

Shape: Square
Diameter (mm): 116
Diameter (in): 4 5/16
Height (mm): 104
Height (in): 4 1/8
Light Distribution: Direct
Weight (kg): 0.900
Weight (lbs): 1.98
Installation Requirement: Housing box
Diffuser: Extra clear glass 6mm
Fixture Finish: ASB / SST
Fixture Material: Stainless Steel AISI 316L
Cable Details: 350mm NS20N PCP 2x0.5 mm2

#### ELECTRICAL

Lamp Type: LED
Input Wattage (W): 8.1
Total Output Wattage (W): 5
Dimming: Non-Dimming / Phase Dimming (120Vac only) / 0-10V Dimming
Driver Included: No
Driver Location: Remote
Driver Type: Constant Voltage - Universal
Driver Class: Class 2
Input Voltage (V): 120 - 277
Output Voltage (V): 24

#### LED

Number of LEDs: 1
Color Temperature (°K): 2700 / 3000 / 4000
Max. Delivered Lumen (lm): 515
CRI: >90 CRI
Lamp Life (hrs): 100000

#### OPTICAL

Optic°: 10 / 35 / 50
Beam Angle: Narrow / Medium / Wide
Adjustability: Rotational 360°; Tilt 15°

#### RATINGS AND CERTIFICATIONS

Certified By: Certified for North American Standards
IP rating: IP68 (not for permanent immersion)
IK Rating: IK08
Marine Grade: Stainless Steel AISI 316L



## CALIBER 120 D RECESSED

E12I0036-

PROJECT

TYPE

SPECIFIER

QUANTITY

DATE



E

PROJECT	_____
TYPE	_____
SPECIFIER	_____
QUANTITY	_____
DATE	_____

## CALIBER 120 D RECESSED

### E12I0037-

base number      Color      Finish      Lens  
 Temperature      Options      Options

- To build a product code in our configurator select the specify button on the base model # product page
- To build a manual product code on this datasheet choose from the options listed below in blue font and add the suffix to the base model #

#### GENERAL

Series: Caliber  
 Subseries: Caliber 120 D  
 Brand: Unonovesette  
 Division: Exterior  
 Mounting Type: Recessed  
 Mounting Location: In-Ground  
 Subcategory: Drive Over

#### PHYSICAL

Shape: Square  
 Diameter (mm): 116  
 Diameter (in): 4 5/16  
 Height (mm): 104  
 Height (in): 4 1/8  
 Light Distribution: Direct  
 Weight (kg): 0.900  
 Weight (lbs): 1.98  
 Installation Requirement: Housing box  
 Diffuser: Extra clear glass 6mm  
 Fixture Finish: [ASB / SST](#)  
 Fixture Material: Stainless Steel AISI 316L  
 Cable Details: 350mm NS20N PCP 2x0.5 mm2

#### ELECTRICAL

Lamp Type: LED  
 Input Wattage (W): 9.04  
 Total Output Wattage (W): 8.5  
 Dimming: Non-Dimming / Phase Dimming (120Vac only) / 0-10V Dimming  
 Driver Included: No  
 Driver Location: Remote  
 Driver Type: Constant Voltage - Universal  
 Driver Class: Class 2  
 Input Voltage (V): 120 - 277  
 Output Voltage (V): 24

#### LED

Number of LEDs: 1  
 Color Temperature (°K): [2700 / 3000 / 4000](#)  
 Max. Delivered Lumen (lm): 730 (3000K)  
 CRI: >90 CRI  
 Lamp Life (hrs): 100000

#### OPTICAL

Optic°: [10 / 35 / 50](#)  
 Beam Angle: Narrow / Medium / Wide  
 Adjustability: Rotational 360°; Tilt 15°

#### RATINGS AND CERTIFICATIONS

Certified By: Certified for North American Standards  
 IP rating: IP68 (not for permanent immersion)  
 IK Rating: IK08  
 Marine Grade: Stainless Steel AISI 316L

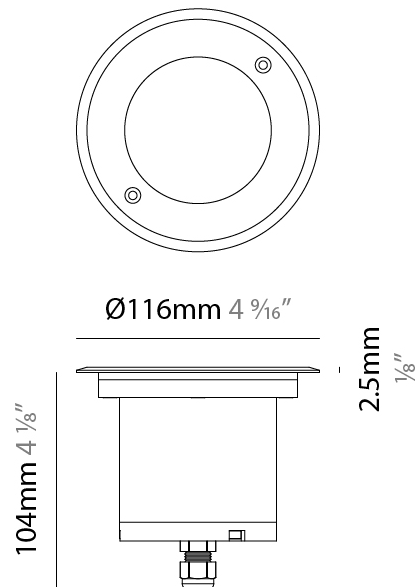

## CALIBER 120 D RECESSED

E12I0037-

PROJECT

TYPE

SPECIFIER

QUANTITY

DATE



## CALIBER 120 D RECESSED

**E12I0039-** -

base number      Color      Finish  
 Temperature      Options

PROJECT
TYPE
SPECIFIER
QUANTITY
DATE

- To build a product code in our configurator select the specify button on the base model # product page
- To build a manual product code on this datasheet choose from the options listed below in blue font and add the suffix to the base model #

### GENERAL

Series: Caliber  
 Subseries: Caliber 120 D  
 Brand: Unonovesette  
 Division: Exterior  
 Mounting Type: Recessed  
 Mounting Location: In-Ground  
 Subcategory: Drive Over

### PHYSICAL

Shape: Square  
 Diameter (mm): 116  
 Diameter (in): 4 5/16  
 Height (mm): 104  
 Height (in): 4 1/8  
 Light Distribution: Direct  
 Weight (kg): 0.900  
 Weight (lbs): 1.98  
 Installation Requirement: Housing box  
 Diffuser: Extra clear glass 6mm  
 Fixture Finish: [ASB / SST](#)  
 Fixture Material: Stainless Steel AISI 316L  
 Cable Details: 350mm NS20N PCP 2x0.5 mm2

### ELECTRICAL

Lamp Type: LED  
 Input Wattage (W): 10.4  
 Total Output Wattage (W): 8.6  
 Dimming: Non-Dimmable / 0-10V Dimming  
 Driver Included: No  
 Driver Location: Remote  
 Driver Type: Constant Voltage - Universal  
 Driver Class: Class 2  
 Housing: ENCP8  
 Input Voltage (V): 120 - 277  
 Output Voltage (V): 24  
 Constant Voltage (V): 24.06

### LED

Number of LEDs: 1  
 Color Temperature (°K): [RGBW](#)  
 CRI: >90 CRI  
 Lamp Life (hrs): 100000

### OPTICAL

Optic°: 35  
 Beam Angle: Medium  
 Adjustability: Rotational 360°; Tilt 15°

### RATINGS AND CERTIFICATIONS

Certified By: Certified for North American Standards  
 IP rating: IP68 (not for permanent immersion)  
 IK Rating: IK08  
 Marine Grade: Stainless Steel AISI 316L



## CALIBER 120 D RECESSED

E12I0039-

PROJECT

TYPE

SPECIFIER

QUANTITY

DATE



E

PROJECT

TYPE

SPECIFIER

QUANTITY

DATE

### Fixture Finish

Aged Solid Brass - ASB



Stainless Steel - SST



**Digital:** Not all screens are calibrated the same, and therefore, colors will appear differently between screens.

**Physical:** When texture is involved, there will be variations in color, character and tone within a product series and between product families.













### LEGEND

	floor-mounted		pivotal		special LED (upon request) RGB, RGBW, tunable, gold+, meat+, art+, fashion+
	wall and ceiling: recessed and surface mounted		rotating		warm dim / natural dimming LED
	ceiling-mounted and wall-mounted		illuminate tilted		rechargeable battery powered
	wall-mounted		color of suspension cable		fixture with natural vivid LED (upon request)
	omni-directional light distribution		length of suspension cable		color rendering index
	direct light distribution		reflector degree selection		color temperature
	direct/indirect light distribution		super spot		lumen (luminous flux)
	indirect light distribution		lens		efficacy (lumens per watt)
	asymmetric light distribution		lens pack		Unified Glare Rating (UGR) range from 5-40
	aura light distribution		shine ring		marine grade (AISI 316 stainless steel)
	round wall or ceiling cut-out		integrated shine ring with diffuser		walk on
	square wall or ceiling cut-out		free individual colors 01-29		drive on
	the supplied jig specifies the cutout dimensions		individual colors: 00 (free of charge), 01-25 (extra charge)		Dark Sky Compliance
	minimum distance (meters) lamp - object		luminaire part to be colored (F1)		Americans with Disabilities Act (less than 4" off the wall located between 27"-84" from floor)
	recessed depth		luminaire part to be colored (F2)		lamp protected against explosion
	ceiling thickness in mm		luminaire part to be colored (F3)		blown glass using traditional methods by master glass blower
	ceiling thickness selection		luminaire part to be colored (F4)		acoustic material
	dimnable DP (phase), DV (0-10V), DD (dali), DS (step-dim)		luminaire part to be colored (F5)		protection class I, protection insulation
	included or excluded LED driver/transformer/control gear		color of 3-circuit adaptor		protection class II, protection insulation
	separately switchable		indirect diffuser		ETL Certified to UL and CSA Standards
	sensor		direct diffuser		UL Certified to UL and CSA Standards
	remote control		ball-proof (upon request)		CSA Certified to UL and CSA Standards
	available upon request		accessory		Certified for North American Standards

### IP RATING

	protected against ingress of solid bodies greater than 12.5mm (finger)
	protected against ingress of solid bodies greater than 2.5mm protected against sprays of water up to 60 degrees from the vertical (rain)
	protected against ingress of solid bodies greater than 1mm (wire) no protection against the ingress of moisture
	protected against ingress of solid bodies greater than 1mm (wire) protected against sprays of water up to 60 degrees from the vertical (rain)
	protected against ingress of solid bodies greater than 1mm (wire) protected against water splashed from all directions
	protected against limited ingress of dust (wet rooms/covered outdoor areas) protected against water splashed from all directions
	protected against ingress of dust protected against jets of water
	protected against ingress of dust protected against powerful jets of water or heavy seas
	protected against ingress of dust protected against immersion of water between 15cm - 1m for 30 minutes
	protected against ingress of dust protected against immersion of water under pressure for long periods

### IK RATING

	protected against 0.14 joules impact (equivalent to 0.25kg mass dropped from 56mm above the surface)
	protected against 0.2 joules impact (equivalent to 0.25kg mass dropped from 80mm above the surface)
	protected against 0.35 joules impact (equivalent to 0.25kg mass dropped from 140mm above the surface)
	protected against 0.5 joules impact (equivalent to 0.25kg mass dropped from 200mm above the surface)
	protected against 0.7 joules impact (equivalent to 0.25kg mass dropped from 280mm above the surface)
	protected against 1 joules impact (equivalent to 0.25kg mass dropped from 400mm above the surface)
	protected against 2 joules impact (equivalent to 0.5kg mass dropped from 400mm above the surface)
	protected against 5 joules impact (equivalent to 1.7kg mass dropped from 300mm above the surface)
	protected against 10 joules impact (equivalent to 5.0kg mass dropped from 200mm above the surface)
	protected against 20 joules impact (equivalent to 5.0kg mass dropped from 400mm above the surface)